



# Tools Required



*Base*



# Mark post base

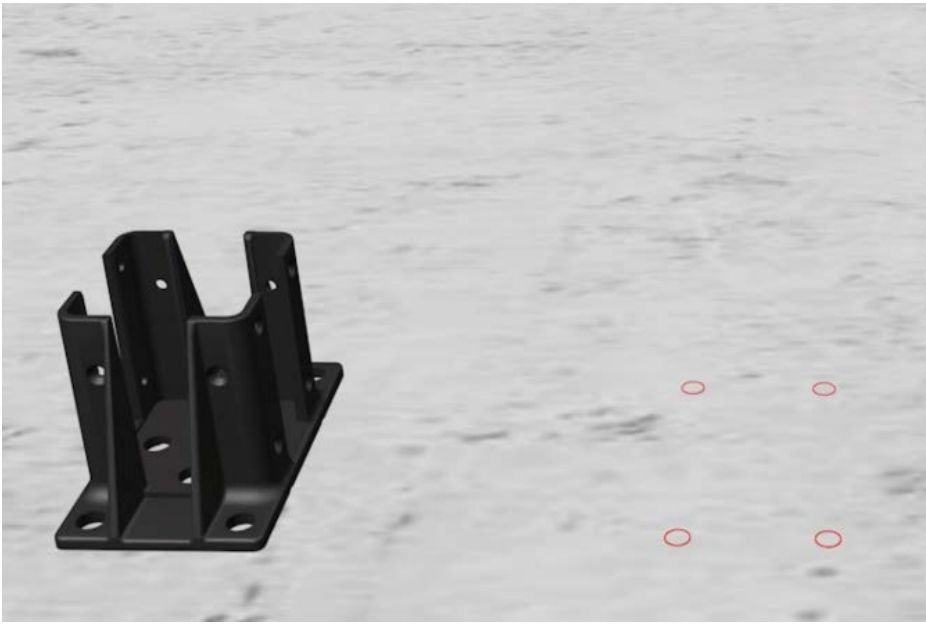

# Install the post base

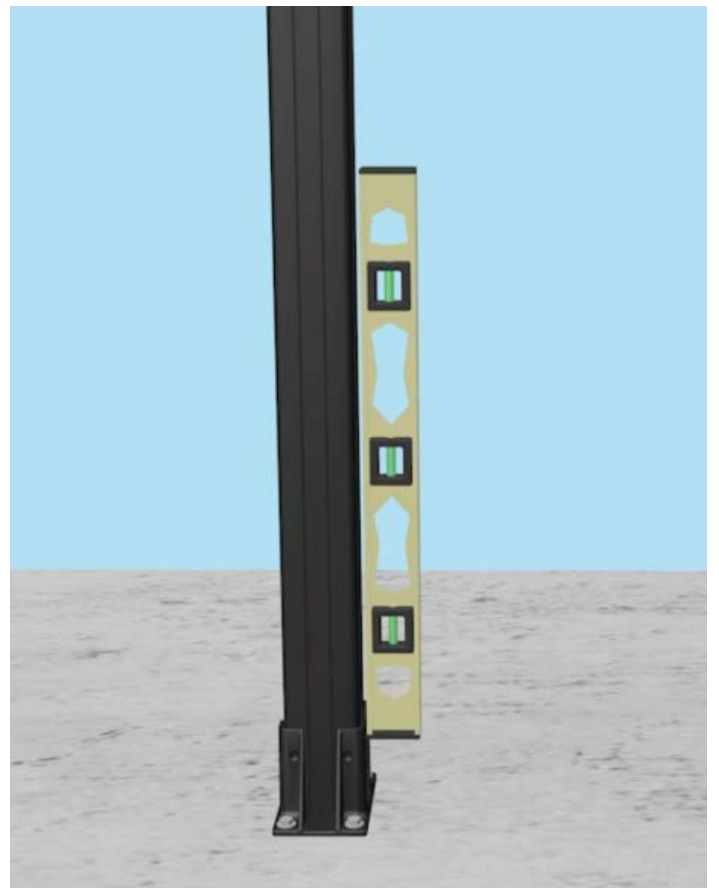
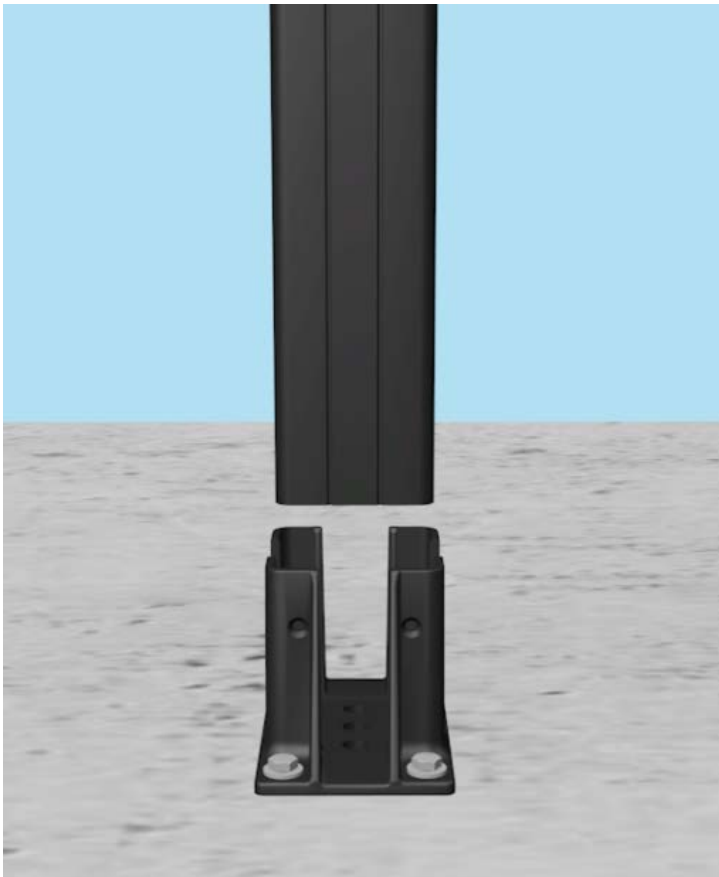

# Secure post base with screws

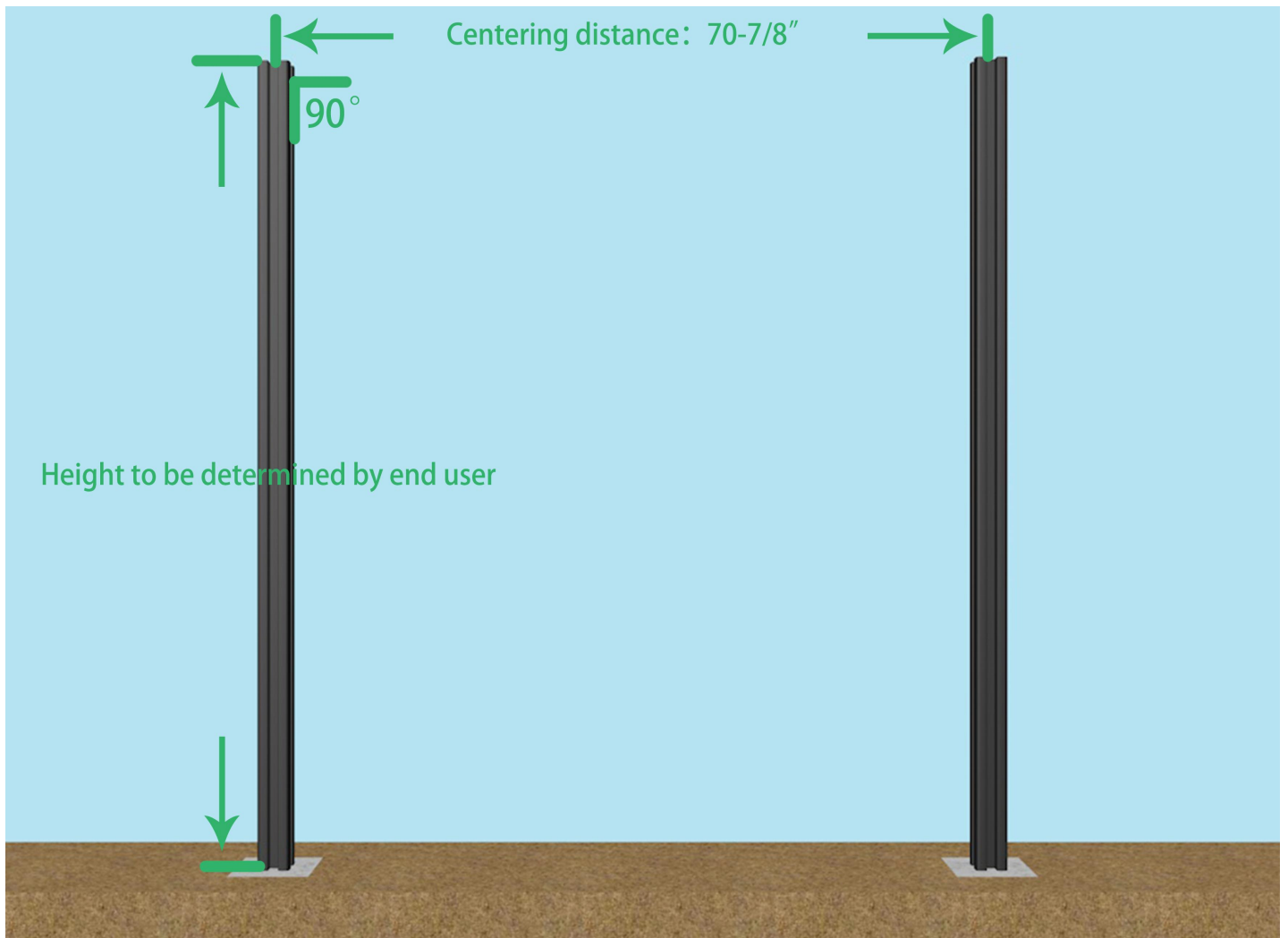
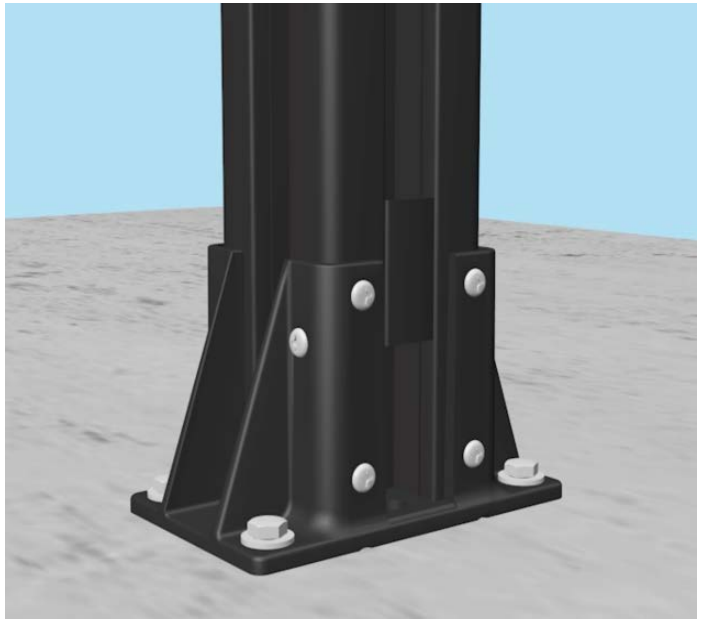
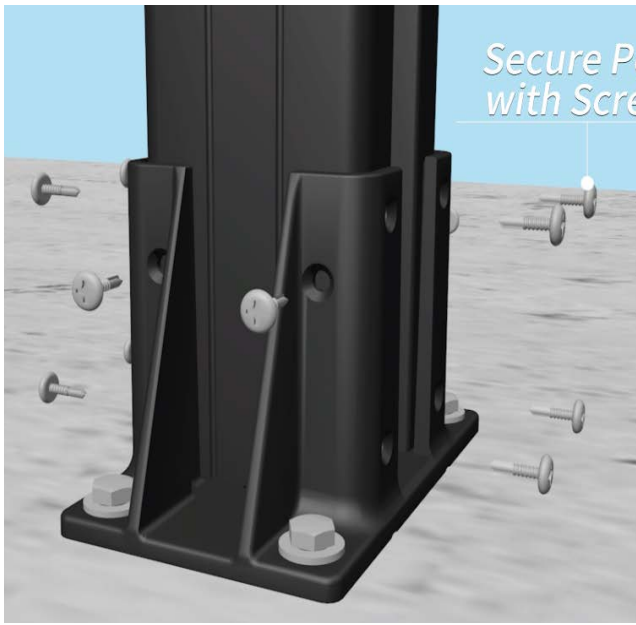

# Insert L support bracket

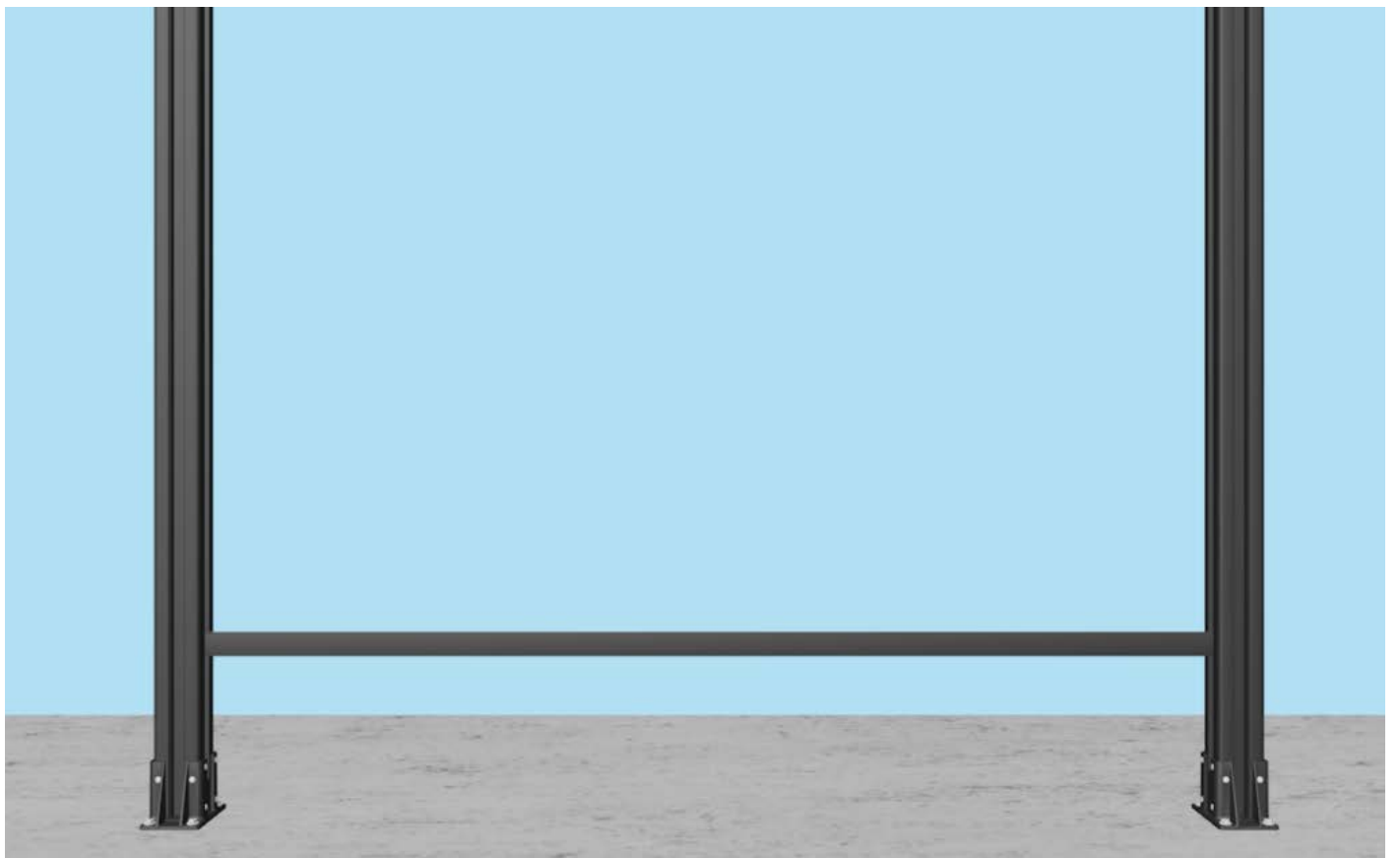
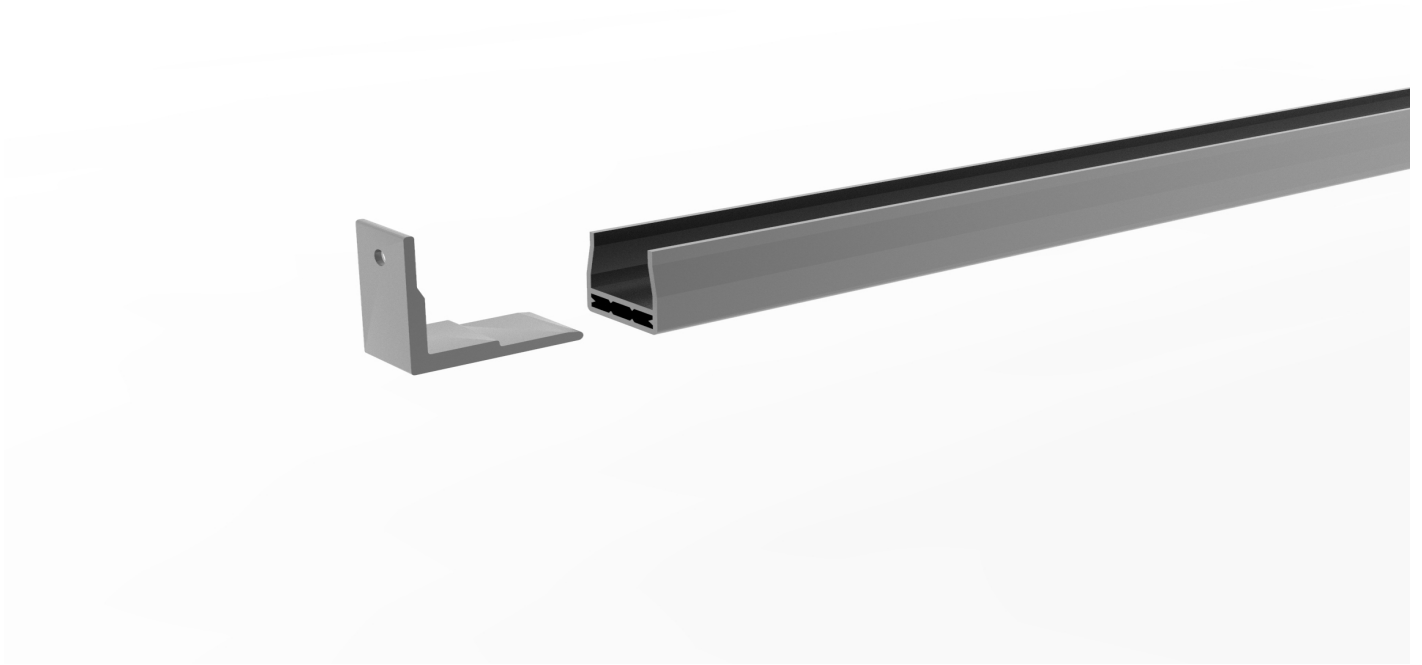

# Install the bottom rail

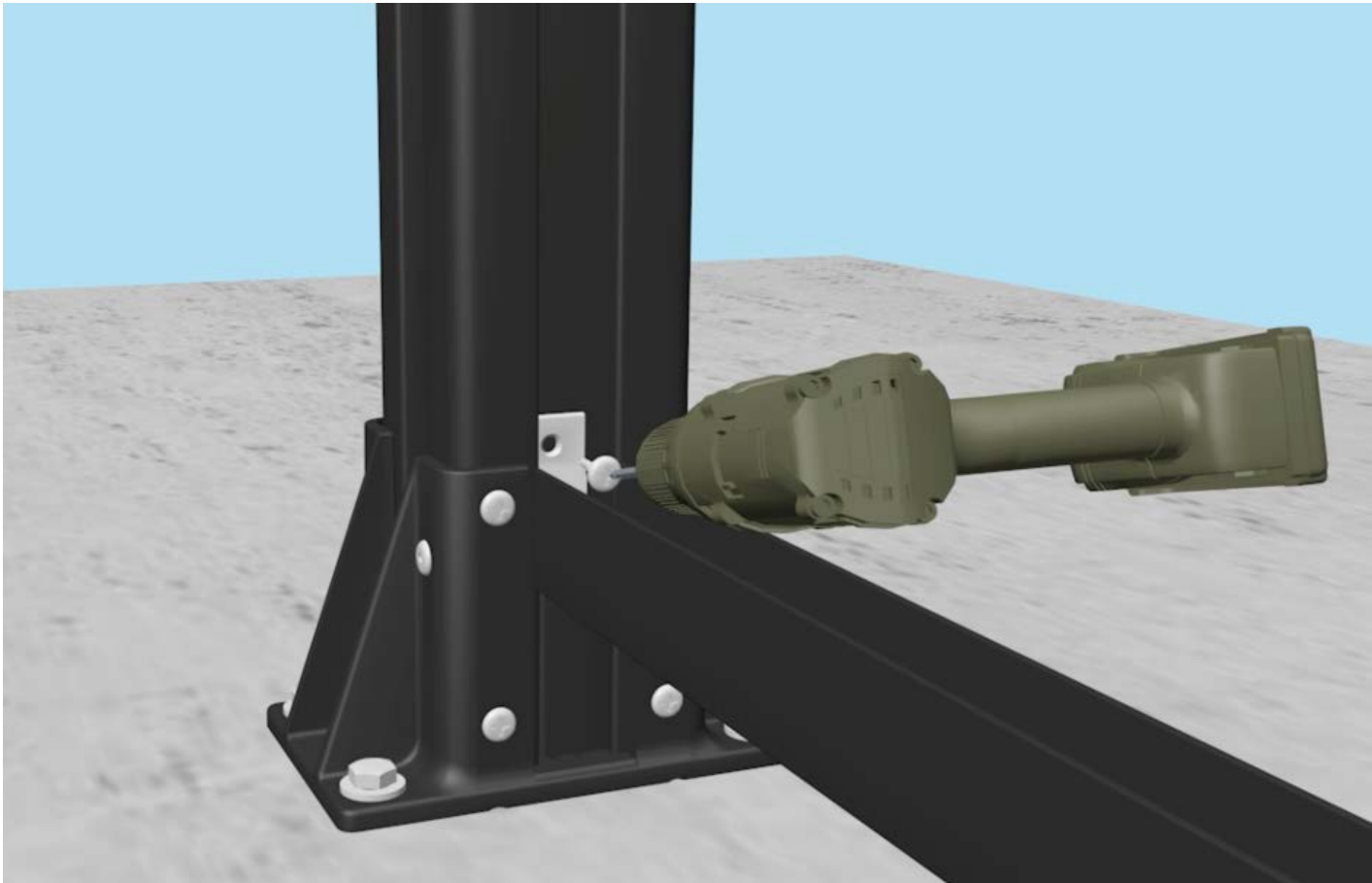

# Install MFP01

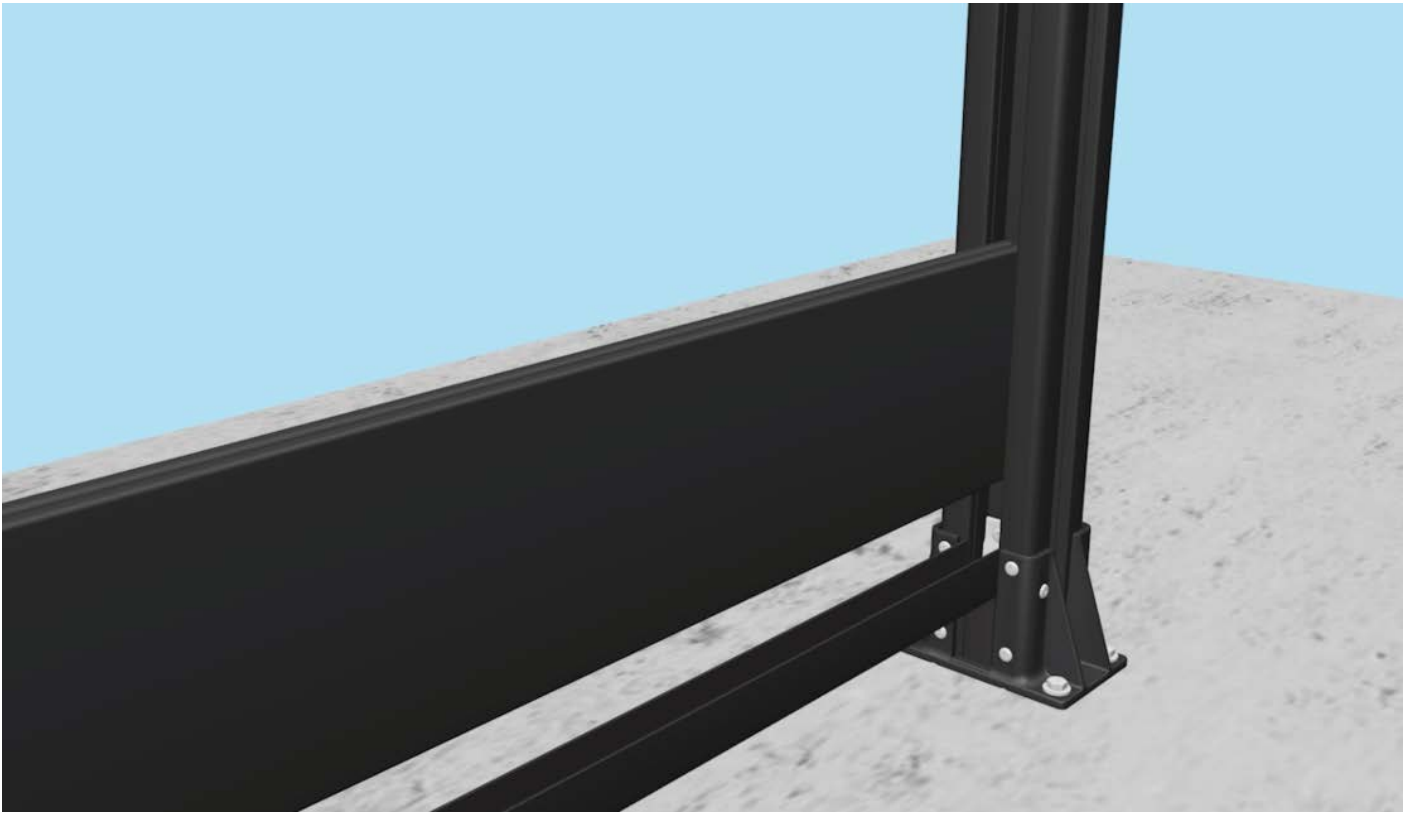



# Install the spacers and side cover spacers, and MFP02

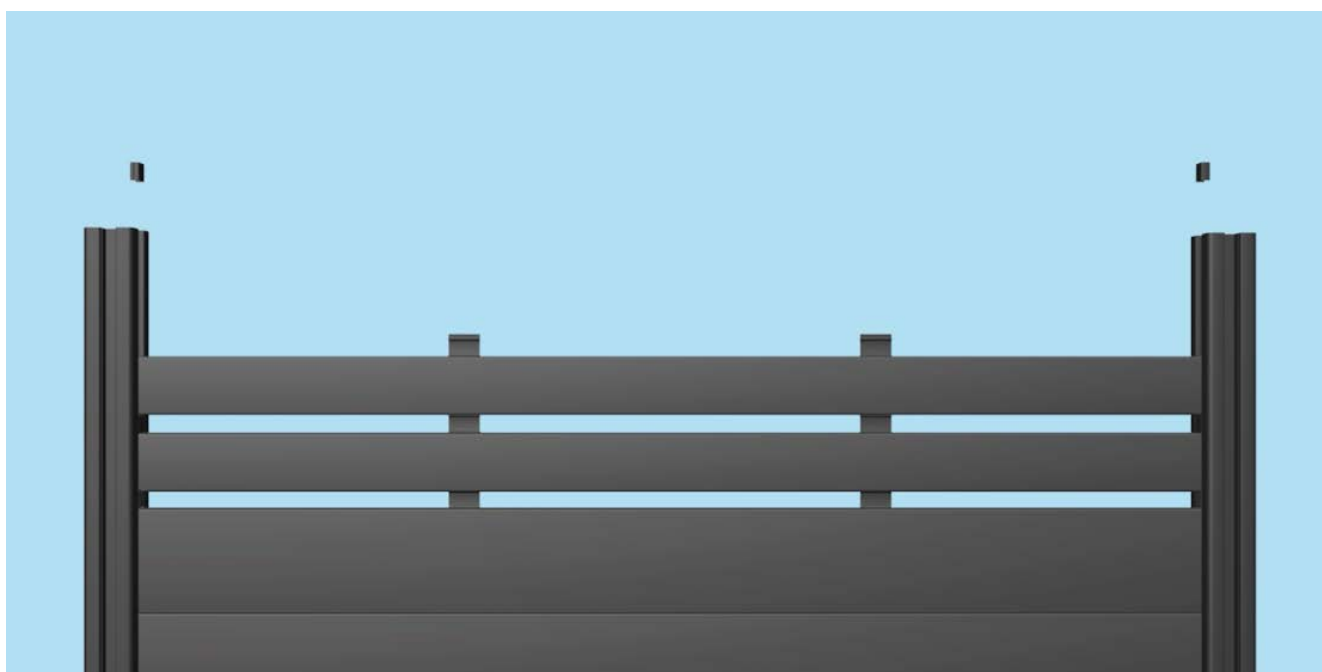
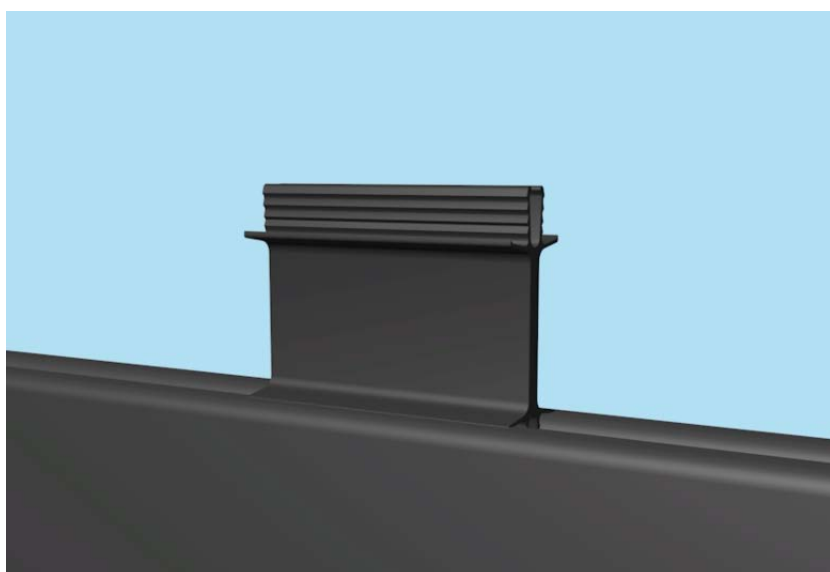
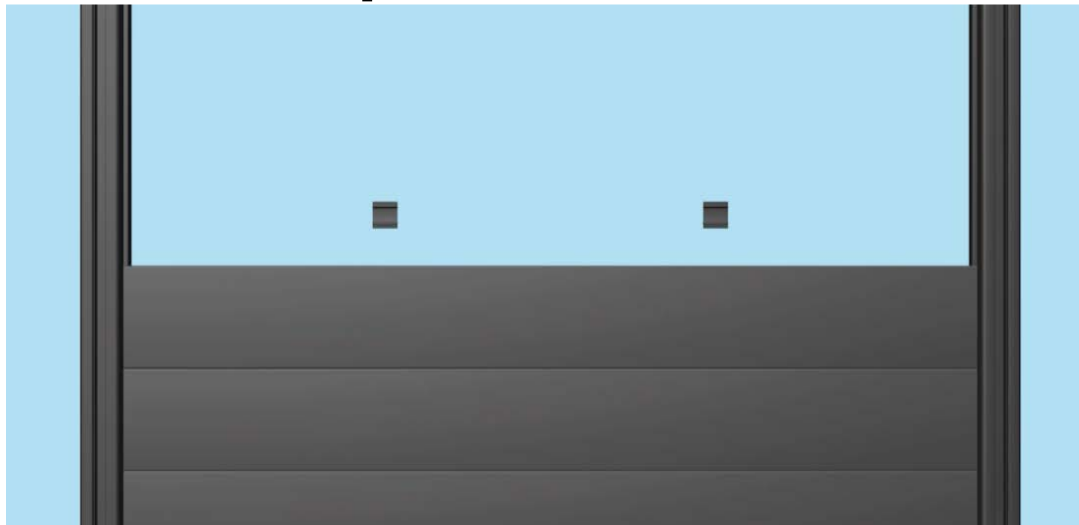

# Insert the L support bracket into the top rail

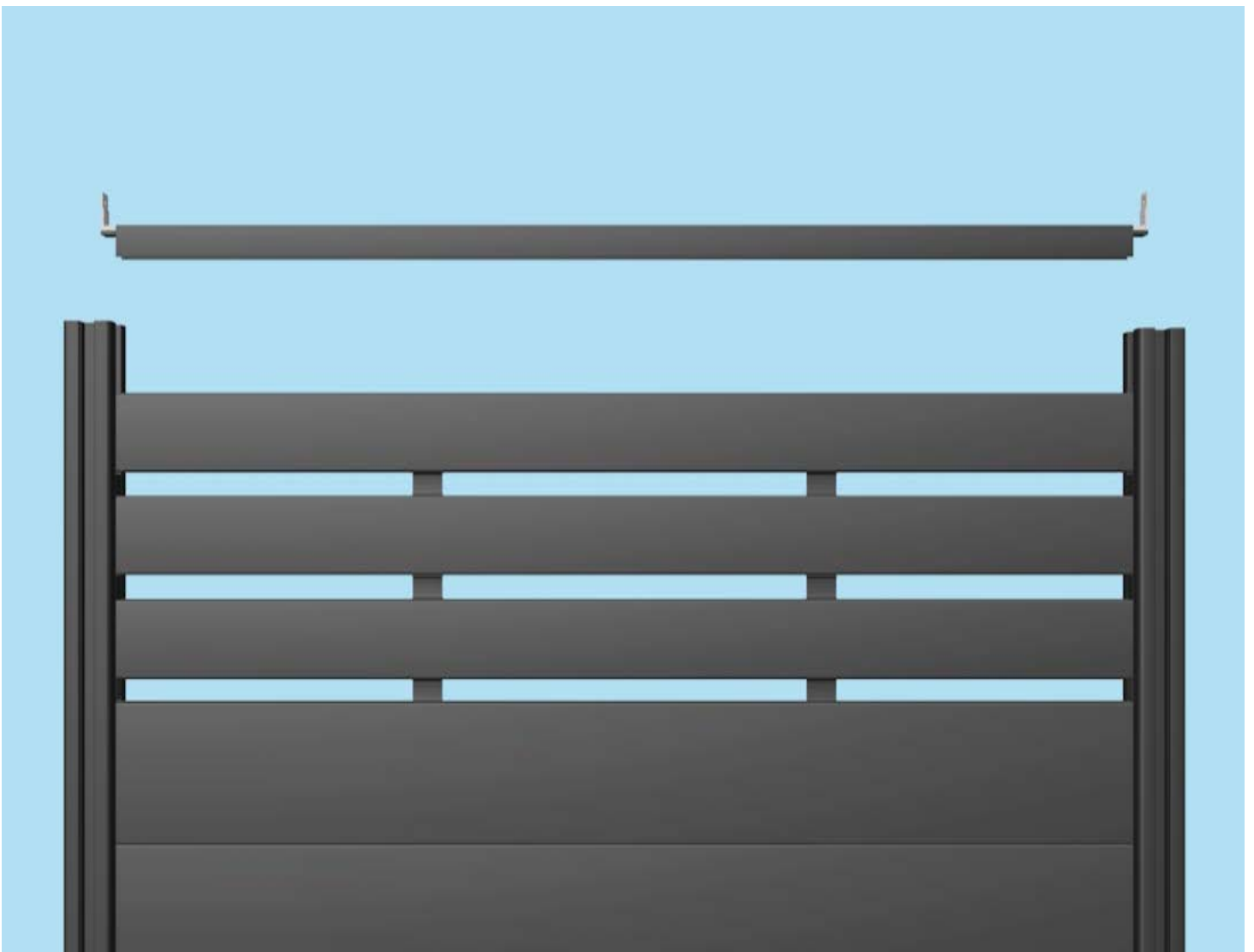
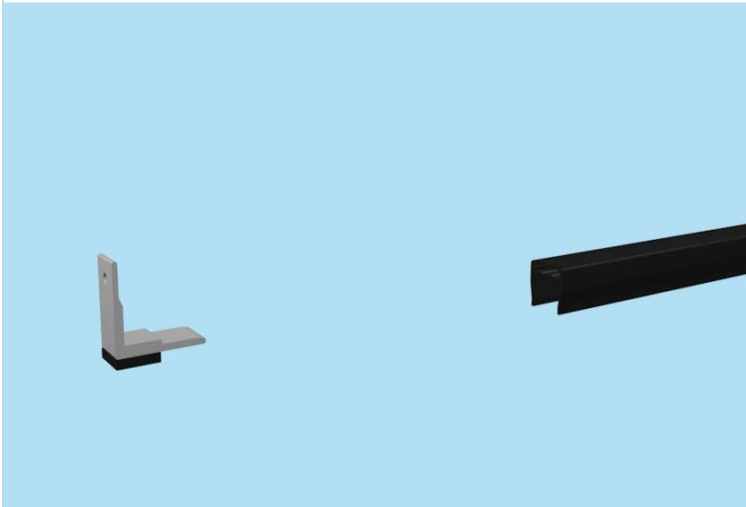

# Install post side cover and cap

